

Door lock motor circuit

WIRING DIAGRAM

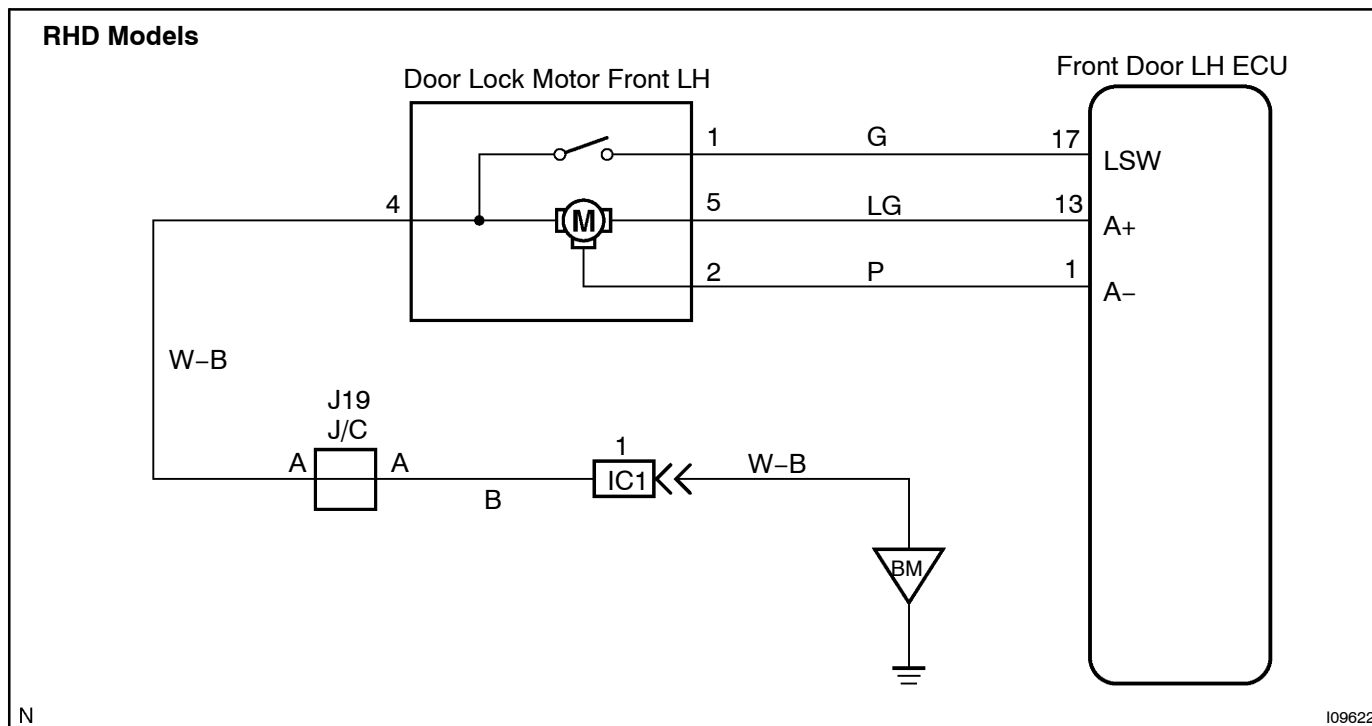
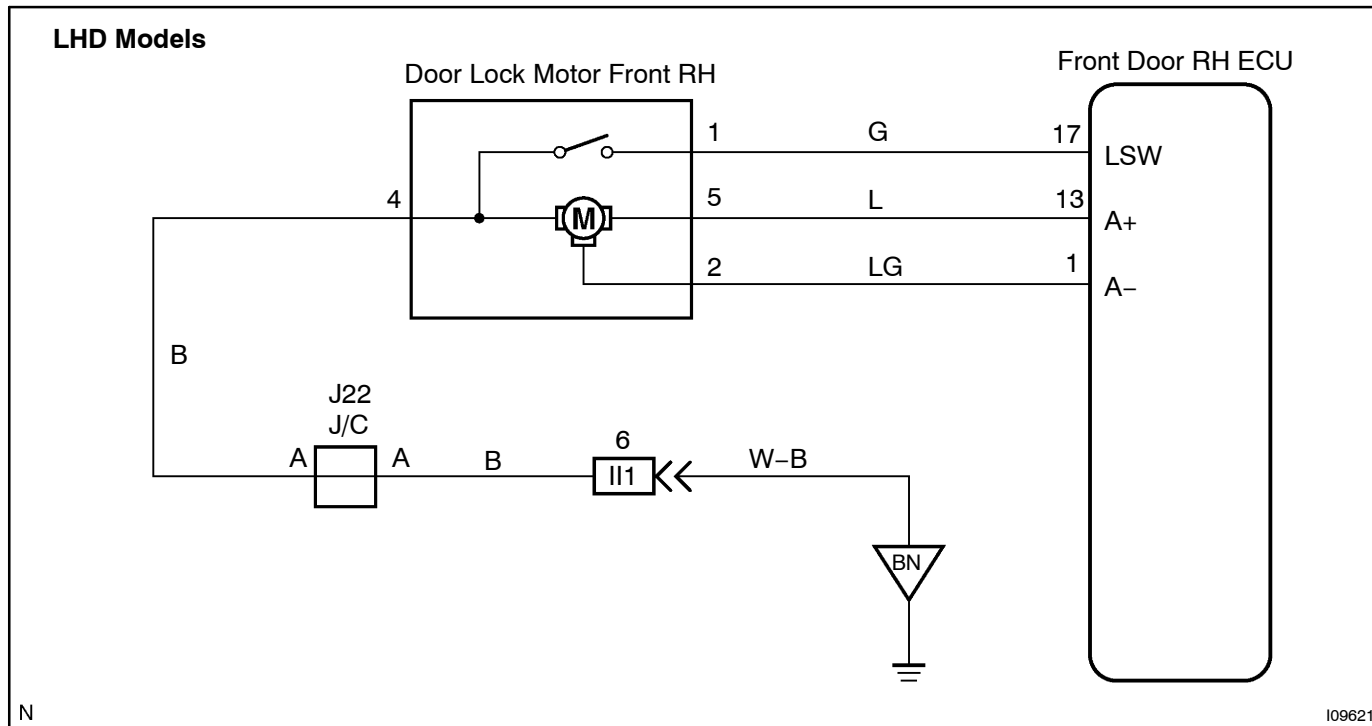

INSPECTION PROCEDURE

1 Check door lock motor (See page BE-92).

NG

Replace the door lock motor.

OK

2 Check wireharness and connector between door lock motor and driver door ECU (See page IN-30).

NG

Repair or replace wireharness or connector.

OK

Proceed to next circuit inspection shown on problem symptoms table (See page DI-584).